

**PHILIPS**

**hue** personal  
wireless  
lighting

**Adore**



HUE serial number



User manual  
Benutzerhandbuch  
Notice d'emploi  
Manual de usuario  
Manual do usuário  
Manuale d'uso

Incl.



Excl.

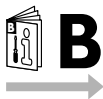
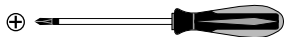
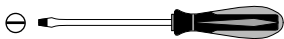
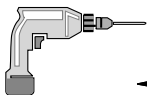

**B**

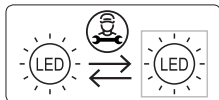
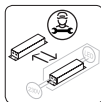
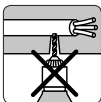
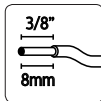
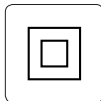
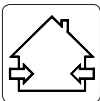

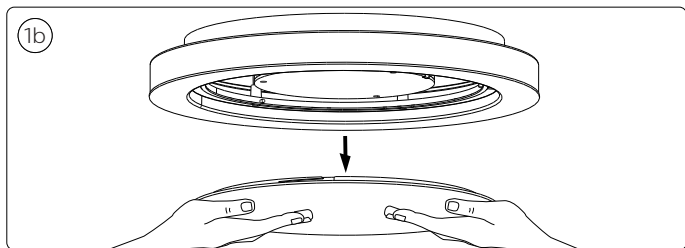
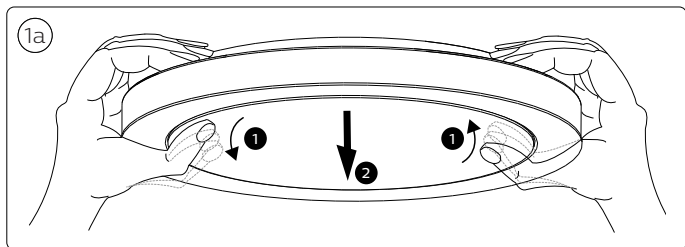
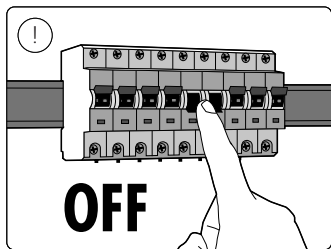

2

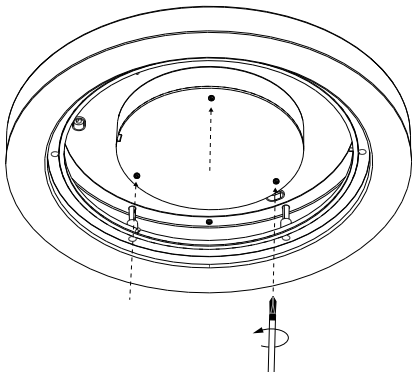

3

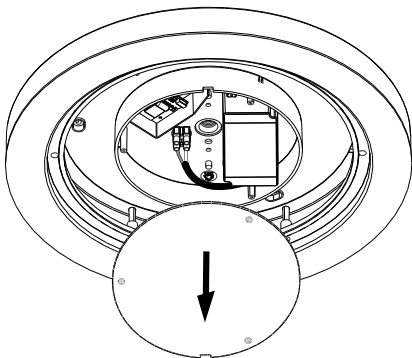

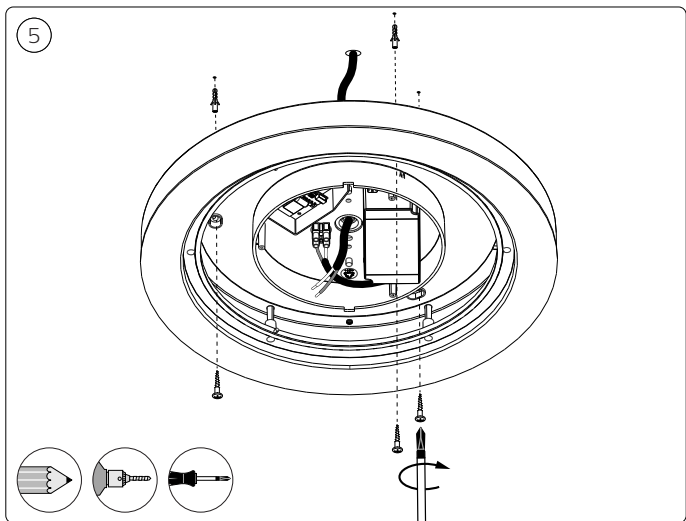
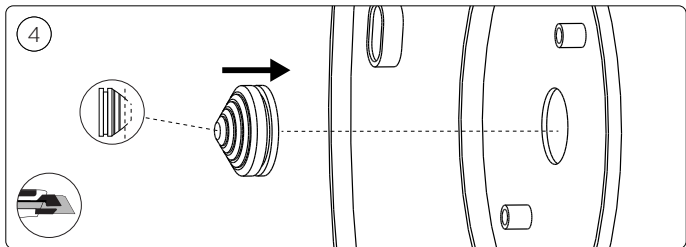

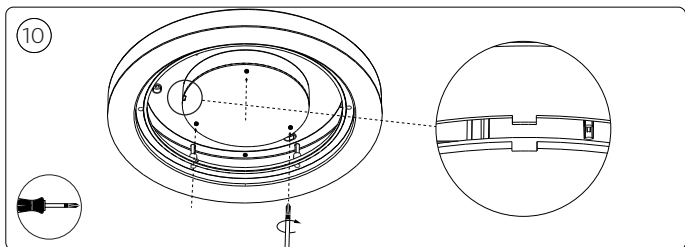
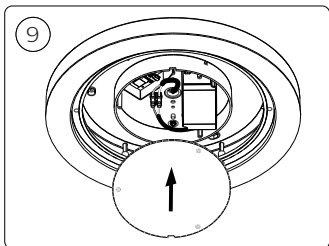
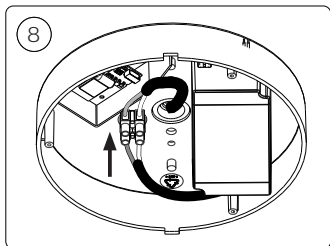
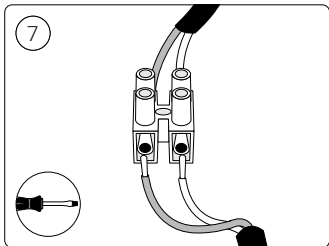
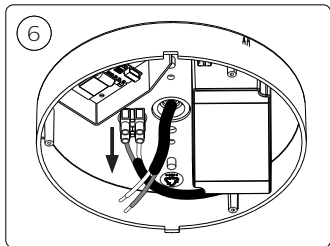

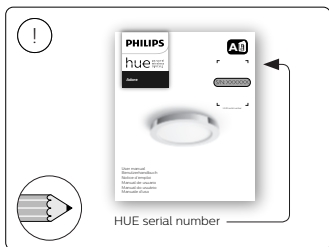
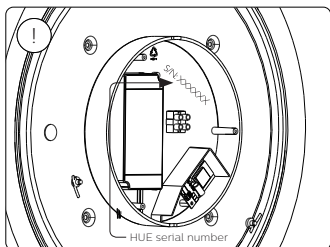
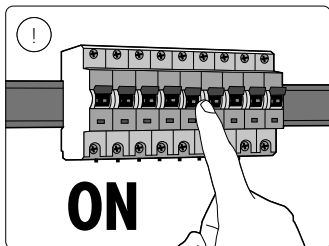
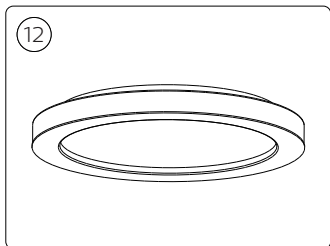
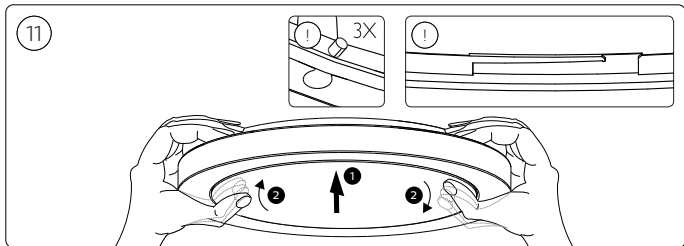

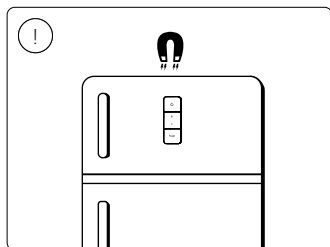
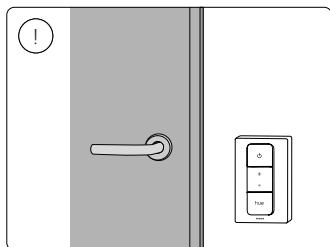
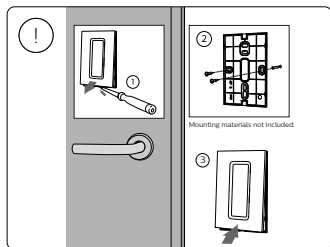
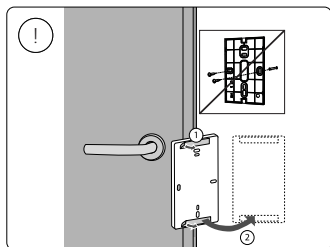
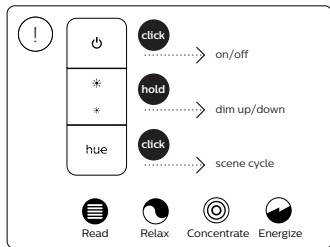
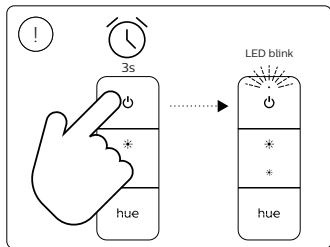



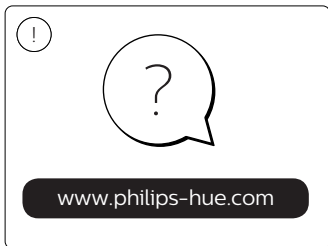
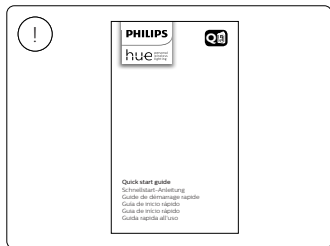







Signify  
I.B.R.S. / C.C.R.I. Numéro 10461  
5600 VB Eindhoven,  
the Netherlands  
☎00800-74454775

© 2021 Signify Holding  
All rights reserved

[www.philips-hue.com](http://www.philips-hue.com)

4404 029 09174  
Last update: 03/2021